

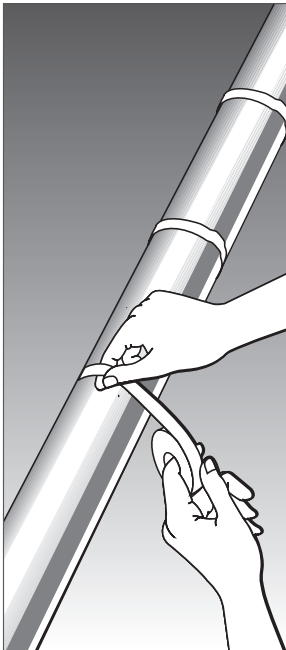

RAYCHEM

Commercial Heat-Tracing

Installation and Maintenance Manual
Self-Regulating Heating Cable Systems



1	General information	1
<hr/>		
2	Product data	2
<hr/>		
3	Heating cable selection	6
<hr/>		
4	Heating cable storage	6
<hr/>		
5	Product checks	7
<hr/>		
6	Components installation	11
<hr/>		
7	Controls, thermal insulation and marking	13
<hr/>		
8	Power supply and electrical connection	15
<hr/>		
9	Heating cable testing	16
<hr/>		
10	Operation, maintenance and pipe repairs	17
<hr/>		
11	Heating cable damage	18
<hr/>		

1 GENERAL INFORMATION

Use of the manual

The Installation and Maintenance manual is for nVent's RAYCHEM self-regulating heating cable systems on thermally insulated pipes. For gutters and downpipes consult the technical handbook.

For self-regulating ground or surface snow melting consult the technical handbook.

For self-regulating floor heating consult the handbook for comfortable warm floors.

For information regarding other applications contact your nVent representative.

Self-Regulating Cables

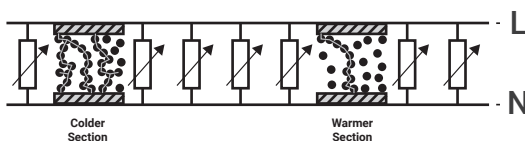

- ▶ Power output varies with temperature.
- ▶ As pipe temperature increases, power output decreases.
- ▶ At high temperatures, the polymer expands, reducing the number of the conductive paths, and thus reducing current flow.
- ▶ At low temperatures, there are many conductive paths, allowing current to flow between the conductors.

Important

For the nVent warranty to apply, the instructions that are included in this manual and product packages must be followed. The installation must be compatible with local requirements applicable to electric heat-tracing systems.

2 NVENT RAYCHEM PRODUCT DATA

Cable type	HWAT-L	HWAT-M	HWAT-R
	Hot water temperature maintenance		
Nominal voltage	230 VAC	230 VAC	230 VAC
Nominal power output (*on insulated metal pipes)	7 W/m at 45°C	9 W/m at 55°C	12 W/m at 70°C
C-type circuit-breaker according to selected kit	max. 20 A	max. 20 A	max. 20 A
Max. circuit length	180 m 20 A	100 m 20 A	100 m 20 A
Min. bending radius	10 mm	10 mm	10 mm
Max. continuous exposure temperature	65°C	65°C	80°C
Max. exposure temperature (power-on condition – 800 h. cumulative)	85°C	85°C	90°C
Max. dimensions in mm (W x H)	13.8 x 6.8	13.7 x 7.6	16.1 x 6.7
Weight	0.12 kg/m	0.12 kg/m	0.14 kg/m
Approvals/Certification	BS / ÖVE / VDE / SEV / CSTB / SVGW / EAC / UKrSEPRO		
Control units	QWT-05 HWAT-ECO	HWAT-ECO	HWAT-ECO
Connection system			
Junction box	–	–	–
Connection and end seal	RayClic	RayClic	RayClic
Support bracket	included in the kit	included in the kit	included in the kit

Warning

As with any electrical equipment or wiring installation operating at line voltages, heating cable and component damage or incorrect installation that allows the penetration of moisture or contamination can lead to electrical tracking, arcing and potential fire hazard.

FS-A-2X	FS-B-2X	FS-C-2X	FS-C10-2X
Frost protection for pipes		Frost protection of pipes/ Temperature maintenance	Frost protection for pipes
230 VAC	230 VAC	230 VAC	230 VAC
10 W/m at 5°C	26 W/m at 5°C	31 W/m at 5°C 22 W/m at 40°C	10 W/m at 5°C
max. 16 A	max. 16 A	max. 16 A	max. 25 A
150 m 16 A	105 m 16 A	90 m 16 A	180 m 20 A
10 mm	10 mm	10 mm	10 mm
65°C	65°C	95°C	90°C
85°C	85°C	95°C	90°C
13.7 x 6.2	13.7 x 6.2	12.7 x 5.3	16 x 6.8
0.13 kg/m	0.13 kg/m	0.13 kg/m	0.14 kg/m
DVGW / CE / VDE / EAC / UKrSEPRO			
AT-TS-13 AT-TS-14 RAYSTAT-CONTROL RAYSTAT-ECO RAYSTAT-CONTROL-11-DIN	AT-TS-13 AT-TS-14 RAYSTAT-CONTROL RAYSTAT-ECO RAYSTAT-CONTROL-11-DIN	AT-TS-13 AT-TS-14 RAYSTAT-CONTROL RAYSTAT-CONTROL-11-DIN	RAYSTAT-CONTROL-10 RAYSTAT-ECO-10 RAYSTAT-CONTROL-11-DIN* AT-TS-13* AT-TS-14* *maximum circuit of 150m
–	–	JB16-02	JB16-02
RayClic	RayClic	CE20-01	CE20-01 CE25-21
included in the kit	included in the kit	JB-SB-08	JB-SB-08

**Do not connect heating cable conductors together or this will result in a short circuit.
Any unconnected heating cable end must be sealed with a nVent approved end seal.**

Cable type	FroStop-Green	FroStop-Black	GM-2X (T)	8BTV2-CT
Product/ Application	Frost Protection for pipes	Frost protection of pipes / Ice and snow protection of gutters and downpipes	Ice and snow protection of gutters and downpipes	Drain heating for ramp drainage systems
Nominal voltage	230 VAC	230 Vac	230 VAC	230 VAC
Nominal power output (on insulated metal pipes)	10 W/m at 5°C	16 W/m at 5°C	36 W/m in ice and 18 W/m in air at 0°C	26W/m at 5°C
C-type circuit-breaker according to selected kit	max. 16 A	max. 16 A	max. 20 A	max. 16 A
Max. circuit length	100 m 16 A	80 m 16 A	80 m 20 A	80 m 16 A 0°C startup
Min. bending radius	10 mm	10 mm	10 mm	10 mm
Max. continuous exposure temperature	65°C	65°C	65°C	65°C
Max. exposure temperature (power-on condition – 800 h. cumulative)	65°C	65°C	85°C	85°C
Max. dimensions in mm (W x H)	12.5 x 5.3	12.5 x 5.3	13.7 x 6.2	13.7 x 6.2
Weight	0.13 kg/m	0.13kg/m	0.13 kg/m	0.13kg/m
Approvals	BS / ÖVE / VDE / SEV / CSTB / SVGW / DVGW / CE / VDE / EAC			
Control units	AT-TS-13 AT-TS-14 RAYSTAT-ECO-10 RAYSTAT-CONTROL-10 RAYSTAT-CONTROL-11 -DIN	EMDR-10 / HTS-D AT-TS-13 AT-TS-14 RAYSTAT-ECO-10 RAYSTAT-CONTROL-10 RAYSTAT-CONTROL-11- DIN	EMDR-10 HTS-D* * max circuit of 30 m	VIA-DU-20 EMDR-10
Connection system				
Junction box	JB16-02	JB16-02	–	JB16-02
Connection kit	CE20-01	CE20-01	RayClic CCE-03-CR	C25-21 E-06 CE25-21
Support bracket	JB-SB-08	JB-SB-08	included in the kit	JB-SB-08

Warning

As with any electrical equipment or wiring installation operating at line voltages, heating cable and component damage or incorrect installation that allows the penetration of moisture or contamination can lead to electrical tracking, arcing and potential fire hazard.

EM2-XR	EM2-R	R-ETL-A	R-ETL-B	R-ETL-A-CR	R-ETL-B-CR	T2Red
Ramp and accessway heating	Ramp and accessway heating	Frost protection for pipes	Frost Protection for pipes	Frost Protection for pipes	Frost Protection for pipes	Underfloor heating
230 VAC	230 VAC	230 VAC	230 VAC	230 VAC	230 VAC	230 VAC
90 W/m at 0°C in concrete	80 W/m at 0°C in concrete	10 W/m at 5°C on pipe	16W/m at 5DegC on pipe.	10W/m at 5DegC on pipe.	16W/m at 5DegC on pipe.	60-100 W/m ²
max. 50 A	max. 32 A	max. 10 A	Max. 16A	Max. 10A	Max. 16A	max. 10 A
85 m 50 A	75 m 32 A	100 m 10 A	100 m 16A	100 m 10A	100 m 16A	100 m 10 A
50 mm	50 mm	10 mm	10 mm	10 mm	10 mm	10 mm
100°C	90°C	65°C	65°C	65°C	65°C	65°C
110°C	90°C	65°C	65°C	65°C	65°C	65°C
18.9 x 9.5	13.7 x 6.2	8,5 x 5,8	8.5 x 5.8	8.5 x 5.8	8.5 x 5.8	6,0 x 8,7
0.27 kg/m	0.13 kg/m	0.07 kg/m	0.07kg/m	0.07kg/m	0.07kg/m	0.07 kg/m
CE						
VIA-DU-20	VIA-DU-20	AT-TS-13 AT-TS-14 RAYSTAT-CONTROL RAYSTAT-ECO Raystat-CON-TROL-11-DIN SBS-R-FP control panels	AT-TS-13 AT-TS-14 RayStat-ECO-10 RayStat-CON-TROL-11-DIN SBS-R-FP Panels	T-TS-13 AT-TS-14 RayStat-ECO-10 RayStat-CON-TROL-11-DIN SBS-R-FP Panels	AT-TS-13 AT-TS-14 RayStat-ECO-10 RayStat-CON-TROL-11-DIN SBS-R-FP Panels	NRG Temp
VIA-JB2	JB-82	JB16-02	JB16-02	JB16-02	JB16-02	-
VIA-CE1	CCE-04-CT	CE-ETL/T2Red	CE-ETL/T2Red U-ACC-PP-07	CE20-03	CE20-03	CE-ETL/T2Red
-	-	-				-

**Do not connect heating cable conductors together or this will result in a short circuit.
Any unconnected heating cable end must be sealed with a nVent approved end seal.**

3 HEATING CABLE SELECTION

Check the design specification to make sure the proper heating cable is selected for each pipe or surface. Refer to nVent product literature or nVent's TraceCalc Net Construction software to select the proper heating cable for each application.

Look-up Table: The following table shows which heating cables are suitable for use with specific applications.

Product/ Application	Frost Protection for Pipes	Hot Water Temperature Maintenance	Ice/Snow Protection of Gutters	Ice/Snow Protection of Ground Surfaces	Underfloor heating/ warming
FS-A-2X	✓				
FS-B-2X	✓				
FS-C-2X	✓				
FS-C10-2X	✓				
FroStop- Green	✓				
FroStop- Black	✓		✓		
HWAT-L		✓			
HWAT-M		✓			
HWAT-R		✓			
GM-2X (T)			✓		
8BTV2-CT			✓		
EM2-XR				✓	
EM2-R				✓	
R-ETL-A-CR R-ETL-B-CR R-ETL-A R-ETL-B	✓				
T2-Red					✓

4 HEATING CABLE STORAGE

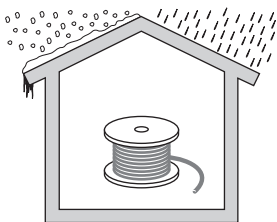

- ⇒ Store in a dry and clean place.
- ⇒ Temperature range: -40°C to +60°C.
- ⇒ Protect any cable ends with an end seal.

5 PRODUCT CHECKS

5.1 Pre-installation checks

Check materials received:

- ▶ Review the heating cable design and compare the list of materials to the catalogue numbers of heating cables and electrical components received to confirm that proper materials are on site. The heating cable type is printed on its outer jacket.
- ▶ Temperature exposure must not exceed that specified in nVent' product literature. Exceeding these limits will impair product performance. Check that expected exposure is within these limits.
- ▶ Ensure that the heating cable voltage rating is suitable for the service voltage available.
- ▶ Do not energize cable when it is coiled or on the reel.
- ▶ Inspect heating cable and components for in-transit damage. An insulation resistance test (see section 10) on each reel is recommended.

Check piping to be traced:

- ▶ Ensure all pressure testing is complete and pipework has final paint coating.
- ▶ Walk the system and plan the routing of the heating cable on the pipe.
- ▶ Check pipework against specification drawing. If different consult design authority.
- ▶ Inspect piping for burrs, rough surfaces, sharp edges etc. which could damage the heating cable. Smooth off or cover with layers of glass cloth tape or aluminium foil.

5.2 Heating cable handling

Heating cable handling tips:

- Paint and pipe coatings must be dry to the touch before heating cable installation.
- When pulling the heating cable, **avoid**:
 - ◇ sharp edges
 - ◇ high tractive force
 - ◇ kinking and crushing
 - ◇ walking or driving over the cable
 - ◇ moisture at cable interfaces

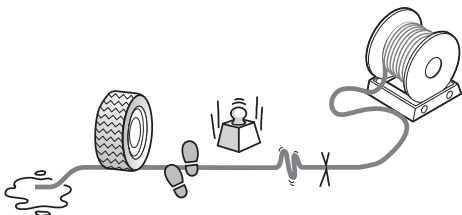

Heating cable pulling tips:

- Use a reel holder that pays out smoothly with little tension.
- Keep heating cable strung loosely but close to the pipe being traced to avoid interference with supports and equipment.
- Pay out designed length and mark (i.e. with fixing tape) on cable while still on reel.
- Leave the appropriate amount of heating cable at all power connection, splice, tee and end seal locations. (Refer to component installation instructions)
- ◇ **Add additional heating cable to trace the fittings and supports or for spiralling as required by the design specifications, or consult nVent product literature for design.**
- Protect all heating cable ends from moisture, contamination and mechanical damage or other interference if left exposed before component installation.

5.3.1 Heating cable on pipe attachment recommendations

- The heating cable may be installed straight (spiralled or in multiple runs as required by the design specification, nVent product literature or TraceCalc software).
- ◇ **Do not** use metal attachments, vinyl electrical tape or duct tape as heating cable damage may result.
- ◇ Self-regulating technology allows for the multiple overlapping of the heating cable on to itself.

5.3.2 Heating cable, non-pipe fixing recommendations

- For snow and ice protection applications, the heating cable should be fixed in place using one of the nVent recommended fixing methods, including spacer rail or connection to a reinforcement grid.
- For gutter applications, the heater should be held in place within the gutter using recommended fixing clips as supplied by the manufacturer.
- For underfloor heating applications, the heater shall be installed using the fixing methods of the manufacture or installed in the nVent RAYCHEM T2Reflecta heat reflector product.

5.4 Straight tracing

- Straight trace the pipe unless the design calls for spiralling.
- On horizontal pipes, fix on lower quadrant (5 O'clock or 7 O'clock positioning on pipe) and not on bottom of pipe.
- Read the kit installation instructions and plan the component location before permanently attaching the cable to the pipe.
- Thermally insulate and weatherproof to specification.

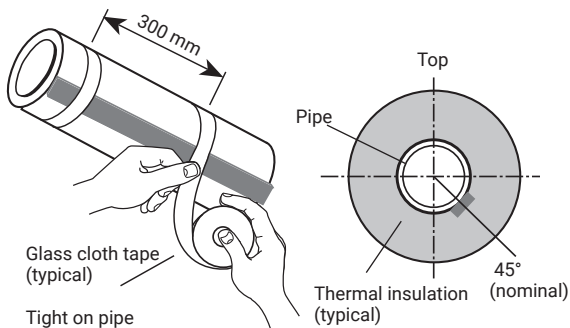

nVent attachment tapes:

- | | |
|---------|---|
| GT66 | Self-adhesive glass cloth tape General purpose tape. GS-54 Self-adhesive glass cloth tape for stainless-steel pipes. KBL-10 cable ties |
| ATE-180 | Aluminium fixing tape. Using only if required for the system design (Typically for temperature maintenance applications such as HWAT on plastic pipes). |

5.5 Cutting the heating cable

- ▶ Cut the heating cable to length after it is attached to the pipe. Before cutting it, confirm the tracing allowance as per Section 2.
- ▶ RAYCHEM heating cable can be cut-to-length without affecting the heat output per metre.

5.6 Installation details

- ▶ Follow the recommendations for cutting and stripping heating cables; they are included in the component installation instructions.

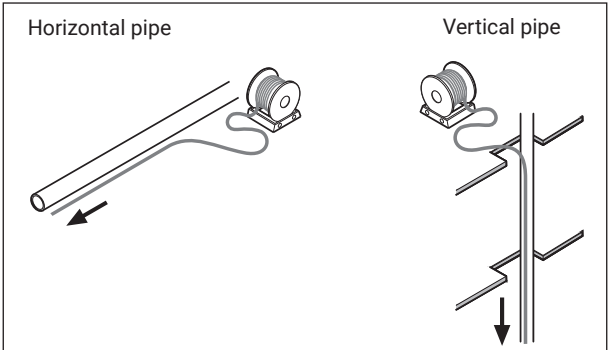

Cut the heating cable at right angles

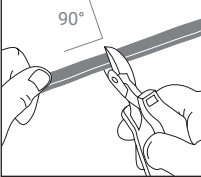

Smallest bending radius: 10 mm

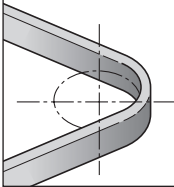

Run the cable over pipe suspensions

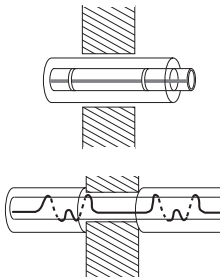
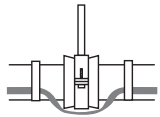

Wall/Floor transit

The thickness of thermal insulation must be continuous otherwise compensate by adding heating cable.

Do not clamp the cable

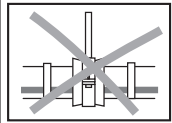

6 COMPONENTS INSTALLATION

General notes:

Select the required components from nVent product literature or use the TraceCalc Net Construction software. nVent RAYCHEM component kits (including power connections, splices and end seals) must be used to satisfy Standards and Approval Body requirements. Installation instructions included in the kit must be followed, including those for preparation of the heating cable conductors for connections. Before assembly, use the guide given in the instructions to ensure that the kit is correct for the heating cable and environment.

- RAYCHEM self-regulating and power-limiting heating cables are parallel circuit design. Do not twist the conductors together as this will result in a short circuit.

6.1 Components required

- For the installation of all components refer to the relevant component installation instructions.
- Required for each heating cable run:
Power connection and end-seal.
- As required:
Splice
Tee-splice: RayClic or junction box, three connection kits and three insulation entry kits, depending on heater.
Accessories (pipe straps, fixing tape, support brackets, labels, etc)

6.2 Component installation hints

- ▶ Locate RayClic / junction boxes for easy access but not exposed to mechanical abuse.
- ▶ Position junction boxes so that power cable and heating cable entries do not point upwards.
- ▶ Fix lids in place where access not required.
- ▶ Confirm junction box stopping plugs are correct for application and fixed firmly in place.
- ▶ Route heating cable from RayClic / junction box to insulation entry so as to avoid possible mechanical damage.
- ◻ **Do not** strain heating cable as it exits/enters RayClic / junction boxes and insulation entries.
- ▶ Ensure heating cable is fixed above pipe straps such as used for RayClic / junction box support brackets.
- ▶ Fix all low profile components (e.g. heatshrink end seals) in place.

7 THERMAL INSULATION AND MARKING

7.1 Pre-insulation checks

- Visually inspect the heating cable and components for correct installation and damage. (See Section 10 if damaged.)
- Insulation resistance (Megger) testing (as per Section 8) is recommended prior to covering the pipe with thermal insulation.

7.2 Thermostats and control systems

- In temperature-sensitive applications, thermostatic control may be necessary. Furthermore, for maximum energy efficiency, nVent requires the installation and use of an approved controller for the application.
- Follow the installation instructions supplied with the thermostat or control. Use the proper wiring diagram for the heating cable layout and control method desired.
- After switching on the heating cable, the cable ends must be warm after 5 to 10 minutes.

7.3 Insulation installation hints

- Correct temperature maintenance requires properly installed and dry thermal insulation.
- Thermally insulate and weatherproof to design specification.
- Check insulation type and thickness against the design specification.
- To minimize potential heating cable damage, insulate as soon as possible after tracing.
- Check that all pipework, including fittings, wall penetrations and other areas, have been completely insulated.
- Ensure that heating cable is not damaged during installation of cladding for example by drills, self-tapping screws and sharp edges of cladding.
- Check that all insulation entry kits are fitted correctly and sealed.
- Ensure that all areas where valve stems, support brackets etc. exit the insulation are appropriately insulated and sealed.

7.4 Marking

- ▶ Install “Electric Traced” signs along piping at suitable intervals (5 m intervals recommended) on alternate sides as a warning.
- ▶ Mark on outside of insulation the location of heating cable components.
- ▶ For outdoor de-icing and snow melting applications, the presence of heat-tracing shall be made evident by the posting of caution signs or marking where clearly visible.

8 ELECTRICAL PROTECTION

8.1 Overcurrent protection

Size circuit breakers according to the design specification or applicable nVent product literature. If devices other than those specifically identified are used, consult the nVent representative for the appropriate sizing information.

8.2 Residual current (earth fault) protection

nVent requires the use of a 30 mA residual current device to provide maximum safety and protection from fire. Ground fault protection is required in any installation.

The metal braid covering the trace heater shall be connected to an earth terminal for electrical protection of the circuit.

9 HEATING CABLE TESTING

9.1 Recommendations

nVent recommends insulation resistance (Megger) test before installing heating cable; before installing thermal insulation; prior to initial start-up (disconnected from the controls).

9.2 Test method

After completing heating cable installation, the insulation resistance between the conductors and the braid should be checked using a 2.500 VDC megger tester. Minimum readings should be 100 Megohms regardless of the heating cable length. The installer should record the original values for each circuit on the installation record sheet (see page 17).

Measurement A

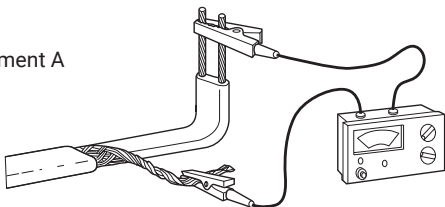

Measurement B

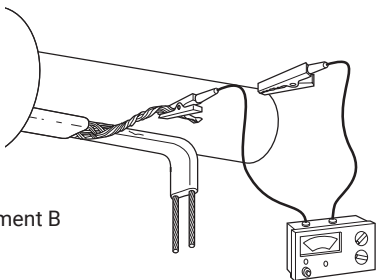

10 OPERATION, MAINTENANCE AND PIPE REPAIRS

10.1 Heating cable operation

- ▶ **Temperature exposure must not exceed that specified in nVent product literature. Exceeding those limitations will shorten the service life and may permanently damage the heating cable.**
- ▶ Pipe insulation must be complete and dry to maintain the correct temperature.

10.2 Inspection and maintenance

De-energise all power circuits before installation or servicing and maintenance.

- ▶ Visual inspection: Exposed heating cable and pipe insulation should be checked periodically to make sure that no physical damage has occurred.
- ▶ Function testing of electrical protection and temperature control systems should be carried out before the winter months each year (see section 10). Temperature maintenance systems should be tested at least twice a year.
- ▶ The Periodic Inspection Record on the following pages should be filled out during maintenance of each circuit in your system.

10.3 Piping systems repair and maintenance

- ▶ Isolate heating cable circuit.
- ▶ Protect the heating cable from mechanical or thermal damage during pipe repair work.
- ▶ Check heating cable installation after pipe repairs and restore thermal insulation following the recommendations in Section 8. Check correct functioning of electrical protection systems.

11 HEATING CABLE DAMAGE

Heating cable damage

- ▶ **Do not repair damaged heating cable.**
Remove entire damaged section and splice in a new length using the appropriate RAYCHEM splice kits.
- ▶ **Replace damaged heating cable at once.**
Damage allowing moisture and contamination to enter the heating cable may result in arcing earth faults and potential fire hazards.
- ▶ Heating cable exposed to fire or flame may cause further fire damage if powered.
Remove from service at once and replace before re-use.

INSTALLATION RECORD SHEET

	CIRCUIT NO.

INSTALLATION RECORDS FOR:

Circuit breaker number

Drawing reference number

Megger test on pipe before insulating
(bypass thermostat if applicable)

	Reading	Initial
		Date

Megger test after insulating (bypass
thermostat if applicable)

	Reading	Initial
		Date

Circuit voltage

	Panel	Connection terminals
--	-------	----------------------

Insulation complete and sealed

	Initial	Date
--	---------	------

Locations of low profile components
are marked on the cladding

	Initial	Date
--	---------	------

REMARKS & COMMENTS:

INSPECTION AND MAINTENANCE RECORD SHEET

CIRCUIT NO.						
-------------	--	--	--	--	--	--

MAINTENANCE CHECKS FOR: _____ MONTH: _____ YR.: _____

No signs of overheating, moisture, or corrosion, etc. Initial _____ Date _____

In connection systems Heating cable and cable glands tight Initial _____
 Connection terminals tight Date _____
 Earth connection tight
 Insulation in good condition

Thermostats set properly and capillaries are protected Initial _____ Date _____

Megger test (bypass thermostat if applicable)	Reading
	Initial
	Date
Circuit voltage	Panel
	Connection terminals
All boxes and thermostats have been firmly closed	Initial
	Date
Locations of low profile components are marked on the cladding	Initial
	Date
REMARKS & COMMENTS:	

TROUBLESHOOTING GUIDE

Symptom	Probable causes
Circuit Breaker overcurrent protection trips or blows.	Electrical fault at: <ul style="list-style-type: none">• damaged heating cable• faulty splices or tees• end seal• connection
	Circuit oversized
	Start-up below design temperature
	Defective electrical protection
Symptom	Probable causes
RCD trips	Earth fault at: <ul style="list-style-type: none">• damaged heating cable• faulty splices or tees• end seal• connection
	<ul style="list-style-type: none">• junction boxes• splices and tees• end seals
	High leakage currents due to a combination of excessive lengths of power cable and heating cable.
	Mains borne disturbances
	Defective RCD

Corrective action

Investigate and remedy (see note 1):

Resize or redesign within Technical Handbook Guidelines. (If larger protection is required, ensure supply cables are compatible).

design for lower start-up temperatures.
reheat pipe from alternative heat source to within exposure temperatures given in Product Data.
energize part of circuit followed by remainder (e.g. in sequence).

Replace

Corrective action

Investigate and remedy (see note 1):

Dry out and reseal or remake immediately.
Perform insulation resistance test.
(100 MΩ minimum)

Redesign

Redesign distribution, guidance is available from nVent.

Replace

Symptom	Probable causes
No power output	Loss of supply voltage due to: <ul style="list-style-type: none"> • overcurrent or residual current protection trip • loose terminals in junction box • loss of supply cable continuity (e.g., open • ircuitued from damage
	Control thermostat is connected in the normally open position
	High resistance connection at: <ul style="list-style-type: none"> • junction box terminals • splices and tees

Symptom	Probable causes
Low pipe temperature	Wet thermal insulation
	Design error
	Incorrect setting or operation of controls e.g., thermostats.
	Heating cable has been exposed to excessive temperature beyond rating.

Note:

Locate faults by the following steps:

- 1 Visually inspect the power connections, splices and end seals for correct installation.
- 2 Look for signs of damage at:
 - a) Valves, pumps, flanges and supports.
 - b) Areas where repairs or maintenance work has been carried out.
- 3 Look for crushed or damaged insulation and cladding along the pipe.

Corrective action

Restore supply voltage

- following A and B (page 20)
- re-tighten terminals

NB: If excessive heating has occurred due to high resistance, replace terminals or crimps

- locate damage and repair
-

Reconnect to normally closed position

Locate and remedy by:

- re-tighten
- repair

NB: If excessive heating has occurred due to high resistance, replace

terminals or crimps

Corrective action

Remove and replace with dry insulation of correct specification and ensure complete weatherproofing

- check with competent authority for design conditions
 - modify to meet nVent recommendations
-

Repair or reset to correct level of operation

Replace

4 If after 1, 2 and 3 above the fault has not been located, then either:

a) Consult nVent for further assistance.

b) Where local practices and conditions allow (e.g., non hazardous areas) isolate one section of heating cable from another by cutting in half and testing (e.g., Insulation Resistance) both halves until general area of damage is found.

Remove insulation and expose fault.

België/Belgique

Tel +32 16 21 35 02

Fax +32 16 21 36 04

salesbelux@nvent.com

Bulgaria

Tel +359 5686 6886

Fax +359 5686 6886

salesee@nvent.com

Česká Republica

Tel +420 602 232 969

czechinfo@nvent.com

Denmark

Tel +45 70 11 04 00

salesdk@nvent.com

Deutschland

Tel 0800 1818205

Fax 0800 1818204

salesde@nvent.com

España

Tel +34 911 59 30 60

Fax +34 900 98 32 64

ntm-sales-es@nvent.com

France

Tél 0800 906045

Fax 0800 906003

salesfr@nvent.com

Hrvatska

Tel +385 1 605 01 88

Fax +385 1 605 01 88

salesee@nvent.com

Italia

Tel +39 02 577 61 51

Fax +39 02 577 61 55 28

salesit@nvent.com

Lietuva/Latvija/Eesti

Tel +370 5 2136633

Fax +370 5 2330084

info.baltic@nvent.com

Magyarország

Tel +36 1 253 4617

Fax +36 1 253 7618

saleshu@nvent.com

Nederland

Tel 0800 0224978

Fax 0800 0224993

salesnl@nvent.com

Norge

Tel +47 66 81 79 90

salesno@nvent.com

Österreich

Tel +43 (2236) 860077

Fax +43 (2236) 860077-5

info-ntm-at@nvent.com

Polska

Tel +48 22 331 29 50

Fax +48 22 331 29 51

salespl@nvent.com

Republic of Kazakhstan

Tel +7 495 926 1885

Fax +7 495 926 18 86

saleskz@nvent.com

Россия

Тел +7 495 926 18 85

Факс +7 495 926 18 86

salesru@nvent.com

Serbia and Montenegro

Tel +381 230 401 770

Fax +381 230 401 770

salesee@nvent.com

Schweiz/Suisse

Tel 0800 551 308

Fax 0800 551 309

info-ntm-ch@nvent.com

Suomi

Puh 0800 11 67 99

salesfi@nvent.com

Sverige

Tel +46 31 335 58 00

salesse@nvent.com

Türkiye

Tel +90 560 977 6467

Fax +32 16 21 36 04

ntm-sales-tr@nvent.com

United Kingdom

Tel 0800 969 013

Fax 0800 968 624

salesthermalUK@nvent.com

**nVent.com**

©2018 nVent. All nVent marks and logos are owned or licensed by nVent Services GmbH or its affiliates. All other trademarks are the property of their respective owners. nVent reserves the right to change specifications without notice.

Raychem-IM-CDE1547-HeatTracing-EN-1805

PCN 1244-009261